

**Obowiązuje od 20-02-2012 r****Meble biurowe grusza polna / grusza jasna**

<b>L.p.</b>	<b>biurka, dostawki do biurek, stoliki i kontenerki do biurek</b>	<b>Cena netto</b>	<b>Cena brutto</b>
1	Biurko <b>B23</b> 160x70/100x74 42kg	410,00	504,30
2	Biurko <b>B25</b> 140x70x74 35kg	272,00	334,56
3	Biurko <b>B26</b> 120x70x74 30kg	250,00	307,50
4	Biurko <b>B27</b> 70x70x74 18kg	210,00	258,30
5	Biurko <b>B28</b> 100x70x74 32kg	310,00	381,30
6	Biurko <b>BR</b> 110x52x68 24kg	176,00	216,48
7	Biurko <b>BK1</b> 100x60x74 37kg	292,00	359,16



8	Biurko <b>BK2</b> 90x60x74 37kg			
9	Biurko <b>BK3</b> 105x65x74 37kg			
10	Kaseta na klaw. <b>Kk1</b> 8kg	67,00	82,41	
11	Biurko <b>Adam I</b> 120x60x75 55kg	550,00	676,50	
12	Biurko <b>Adam II</b> 140x60x75 60kg	650,00	799,50	
13	Końcówka biurka Adam I, II <b>KA</b> śr.80x75 30kg	220,00	270,60	
14	Kontener <b>K22</b> 44x50x62,5 28kg -zamek centralny-	355,00	436,65	
15	Kontener <b>K25</b> 44x70x74 37kg -zamek centralny-	485,00	596,55	
16	Kontener <b>K23</b> 45x45x74 37kg -zamek centralny-	435,00	535,05	
17	Przegroda <b>B23X</b> 160x32x30 6kg	86,00	105,78	



15 Kontener **K25**  
44x70x74 37kg  
-zamek centralny-

16 Kontener **K23**  
45x45x74 37kg  
-zamek centralny-

17 Przegroda **B23X**  
160x32x30 6kg



18	Łącznik <b>P29</b> 70x70 5kg	98,00	120,54
19	Łącznik <b>P25</b> 70x70 5kg	98,00	120,54
20	Łącznik <b>P26</b> 70x70 5kg	98,00	120,54
21	Końcówka <b>P27</b> śr.100x70 11kg	150,00	184,50
22	Końcówka <b>P28</b> śr.140x70 10kg	150,00	184,50
23	Noga satynowa <b>NMS</b> śr.80 x720 4kg	66,00	81,18
24	Noga chrom. <b>NMC</b> Śr.60 x720 4kg	32,00	39,36
25	Stół konferenc. <b>KONF</b> 175x90x75 70kg	575,00	707,25
26	Stół owalny <b>OWAL</b> 120x80x75 50kg	750,00	922,50
27	Stół okrągły <b>R425</b> Śr.85x74 24kg	250,00	307,50

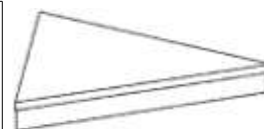

28	Stolik <b>KRZYŚ</b> 75x55x55 14kg	130,00	159,90
29	Podst. na komp. <b>PC</b> 27x50x15,5 6kg	66,00	81,18
30	Szafka na druk. <b>SzD</b> 44x50x56 18kg	230,00	282,90

